



## INSTRUCTION MANUAL

# Blink HQ 200 – Level 2 AC EVSE

Version 3.0



---

© 2022 by Blink Charging Co. Its Affiliates and Subsidiaries (“Blink”)

No part of the contents of this document may be reproduced or transmitted in any form or by any means without the express written permission of Blink. The contents of this document have been verified by the manufacturer to be consistent with the described components; however, inconsistencies sometimes occur. Such inconsistencies should be brought to the attention of a Blink representative. Changes to this manual may be made at any time without notice.

**Disclaimer of Consequential Damages**

Blink is not responsible for the use or application by any person of the materials in this manual. Blink is not responsible for damages, either direct or consequential, arising out of or relating to the use or application of these materials.

Certain sections of this manual are meant as a guide for professional electricians. The manual contains general guidelines and may not provide instructions for your specific situation. Do not attempt installation if you lack the knowledge and understanding required for the installation, otherwise personal injury and/or death as well as property damage or loss could occur.

Electricity is dangerous and can cause personal injury or death as well as other property loss or damage if not used or constructed properly. If you have any doubts whatsoever about performing the installation of the equipment, please do the smart thing and hire a licensed electrician to perform the work for you.

Never work with live voltage. Always disconnect the power source before working with electrical circuits.

When performing the installation, please read and follow this manual. Additionally, always follow your local electrical code and requirements which are specific to local areas.

**Notice**

Changes or modifications not expressly approved by the party responsible for compliance could void the user’s authority to operate the equipment.



Blink, Blink Network, and the Blink logo are registered trademarks of Blink.

SAE J1772™ is a trademark of SAE International®

**Blink**

2404 W. 14th St.  
Tempe, AZ 85281

(888) 998 2546  
[www.BlinkCharging.com](http://www.BlinkCharging.com)

# Table of Contents

- 1. IMPORTANT SAFETY INSTRUCTIONS .....4**
- 2. INTRODUCTION.....6**
- 3. PRODUCT OVERVIEW .....6**
- 4. PRODUCT SPECIFICATIONS .....7**
- 5. PRE-INSTALLATION INSTRUCTIONS.....8**
  - 5.1. SAFETY AND GROUNDING ..... 8
  - 5.2. CONDUIT & BREAKER SIZE GUIDE ..... 9
- 6. INSTALLATION INSTRUCTIONS ..... 10**
  - 6.1. TOOLS REQUIRED FOR INSTALLATION ..... 10
  - 6.2. PARTS REQUIRED FOR INSTALLATION ..... 10
  - 6.3. TERMINAL, WIRE SIZE, AND TEMPERATURE ..... 10
  - 6.4. PRODUCT INSTALLATION ..... 11
- 7. GETTING STARTED ..... 15**
  - 7.1. BROWSER ACCESS..... 15
  - 7.2. WEB PAGE OVERVIEW ..... 17
  - 7.3. CONFIGURATION ..... 21
  - 7.4. MAINTENANCE..... 34
  - 7.5. LLM STATUS..... 35
  - 7.6. SECURITY ..... 46
- 8. OPERATIONS.....47**
  - 8.1. CHARGING STATUS INDICATORS..... 47
  - 8.2. AUTHORIZATION ..... 48
  - 8.3. START CHARGING ..... 49
  - 8.4. STOP CHARGING ..... 49
- 9. GENERAL CARE.....50**
- 10. SUPPLEMENTAL INFORMATION .....51**
  - 10.1. ELECTRICAL SERVICE WIRING (240V SPLIT-PHASE SYSTEM (RESIDENTIAL)) ..... 51
  - 10.2. THREE-PHASE 208 V WYE-CONNECTED ..... 51
  - 10.3. THREE-PHASE 240 V DELTA-CONNECTED ..... 52
- 11. CUSTOMER SUPPORT .....52**

## 1. IMPORTANT SAFETY INSTRUCTIONS

Before installing or using the **Blink Network, LLC** (Blink) electric vehicle supply equipment (EVSE), read all these instructions, paying particular attention to any **WARNING** and **CAUTION** markings in this document and on the Blink Product. You should also review any instructions included with your electric vehicle (EV) as they pertain to vehicle charging.

The following symbols and associated instructions are used throughout this document and relate to action necessary to avoid hazards.

### Legend



**WARNING**

Risk of personal injury



**WARNING: RISK OF ELECTRIC SHOCK**

Risk of electric shock



**WARNING: RISK OF FIRE**

Risk of fire



**CAUTION**

Risk of damage to the equipment

- This product should be installed only by a qualified approved technician.
- Blink is not responsible for physical injury, damage to property or equipment caused by the installation of this device.
- Make sure that the materials used, and the installation procedures, follow local building codes and safety standards.
- The information provided in this manual in no way exempts the user of responsibility to follow all applicable codes or safety standards.
- Review this manual carefully and consult with a licensed contractor, licensed electrician, or trained installation expert to make sure of compliance with local building codes and safety standards.

### Repair and Maintenance Clause

- Only a licensed contractor, licensed electrician, or trained installation expert is allowed to repair or maintain this device. It is forbidden for a general user to repair or maintain this device.
- Any repair or maintenance **MUST** be performed after removing power from this device.
- Moving and Storage Instructions
- Store the product at a temperature between -40 and +80 °C.
- Check the product for damage after moving.
- Carry the product by the sides. Do not lift or carry by either the flexible cord or the EV cable, if provided.

### FCC Rules and Industry Canada License-Exempt RSS Standard(s)

- This device complies with Part 15 of the FCC Rules. Changes or modifications are not expressly approved by the manufacturer could void the user's authority to operate the equipment.
- English: This device complies with Industry Canada license-exempt RSS standard(s). Operation is subject to the following two conditions: (1) this device may not cause interference, and (2) this device must accept any interference, including interference that may cause undesired operation of the device.
- French: Le présent appareil est conforme aux CNR d'Industrie Canada applicables aux appareils radio exempts de licence. 'exploitation est autorisée aux deux conditions suivantes: (1) l'appareil ne doit pas produire de brouillage, et (2) l'utilisateur de l'appareil doit accepter tout brouillage radioélectrique subi, même si le brouillage est susceptible d'en compromettre le fonctionnement.

**WARNING: RISK OF ELECTRIC SHOCK**

Basic precautions should always be followed when using electrical products, including the following:

- Read all the instructions before using this product.
- This device should be supervised when used around children.
- Do not put fingers into the EV connector.
- Do not use this product if the flexible power cord or EV cable is frayed, has broken insulation, or any other signs of damage.
- Do not use this product if the enclosure or the EV connector is broken, cracked, open, or shows any other indication of damage.

**WARNING: RISK OF ELECTRIC SHOCK**

Improper connection of the equipment grounding conductor can result in a risk of electric shock. Check with a qualified electrician or serviceman if you are in doubt as to whether the product is properly grounded.

**WARNING: RISK OF ELECTRIC SHOCK**

- Do not touch live electrical parts.
- Incorrect connections may cause electric shock.

**WARNING**

This equipment is intended only for charging vehicles that do not require ventilation during charging. Please refer to your vehicle's owner's manual to determine ventilation requirements.

**WARNING**

Do not use extender cables to increase the length of the charging cable. The maximum length is limited to 25 feet by the National Fire Protection Agency.

**WARNING: RISK OF FIRE**

To reduce the risk of fire, connect only to a circuit provided with Model HQW2-50C-W1-N1-N-23, HQW2-50C-N1-N1-N-23, HQW2-50C-W1-N2-N-23-D for 50 A; Model MQW2-50C-M2-R1-N-23, HQW2-50C-W1-N1-N-23, HQW2-50C-N1-N1-N-23, MQW2-50C-M2-R2-N-23-D, HQW2-50C-W1-N2-N-23-D for 62.5 A amperes maximum branch circuit overcurrent protection in accordance with the National Electrical Code, ANSI/NFPA 70 and the Canadian Electrical Code, Part I, C22.1.

**General Conventions**

The use of the word "**Note:**" indicates additional information that is relevant to the current process or procedure.

**SAVE THESE INSTRUCTIONS**

## 2. INTRODUCTION

This instruction manual describes how to properly install the Blink HQ 200 – Level 2 AC EVSE (Blink Product). Contact the Blink Support Center at 1-888-998-BLINK (2546) for troubleshooting assistance and additional technical questions.

Unauthorized modification of the Blink Product voids the manufacturer’s warranty.

The Blink Product specified in this document is design for the North American market to charge plug-in electric vehicles (PEVs), plug-in hybrid electric vehicles (PHEVs), and battery electric vehicles (BEVs). It provides Level 2 AC charging that shortens the charging time for typical EVs, when compared to a Level 1 AC EVSE.

## 3. PRODUCT OVERVIEW

MODEL NAME	HQ 200 Smart
MODEL NUMBER	HQW2-50C-W1-N1-N-23 HQW2-50C-W1-N2-N-23-D
PART NUMBER	01-0201 01-0204
PRODUCT VIEW	

Table 1. Product Overview

## 4. PRODUCT SPECIFICATIONS

POWER SPECIFICATIONS	HQ 200 Smart
Maximum Power	12 kW
Standby Power	< 3.6 W
Output Power (208 V)	NEMA 14-50P: 2.5, 3.3, 4.9, 6.6, 8.3 kW Hardwired: 2.5, 3.3, 4.9, 6.6, 8.3, 9.9, 10.4 kW
Output Power (240 V)	NEMA 14-50P: 2.9, 3.8, 5.8, 7.7, 9.6 kW Hardwired: 2.9, 3.8, 5.8, 7.7, 9.6, 11.5, 12 kW
Output Amperage	NEMA 14-50P: 12, 16, 24, 32, 40 A Hardwired: 12, 16, 24, 32, 40, 48, 50 A
Circuit Breaker Options	NEMA 14-50P: 15, 20, 30, 40, 50 A Hardwired: 15, 20, 30, 40, 50, 60, 70 A
Voltage	208/240 VAC
Voltage Range	180 to 264 VAC
Frequency	50, 60 Hz
Input Wiring Type	NEMA 14-50P (Default) Hardwired (Optional)
Input Wiring Scheme	L1, L2, PE
Cold-Load Pickup	Randomized delay between 120 and 720 sec. before charge resumes after a power failure.
Power Measurement Accuracy	Embedded meter with a $\pm 1\%$ accuracy at the nominal input.
Surge Protection	Up to 6 kV at 3,000 A
FUNCTIONAL SPECIFICATIONS	
Charge Connector Type	SAE J1772, Lockable (up to 0.24" or 5mm Shackle Diameter)
Charge Cable Length	23ft. (7.01m)
Demand Response	Yes
Status Indicator	Status & WLAN LEDs, Audio
User Interface	Mobile Application
Digital Assistants	Apple Siri, Google Assistant, Amazon Alexa
Access Control	None
Local Load Management	Client
NETWORK SPECIFICATIONS	
Wireless Local Area Network (LAN)	2.4 and 5 GHz Wi-Fi (802.11 b/g/n/ac)
Wide Area Network (WAN)	None
SAFETY & COMPLIANCE SPECIFICATIONS	
Ground Fault Detection	CCID20, 20 mA per UL 2231, Automatic Reset Feature and Manual Reset Feature
Ground Monitor	Ground Monitor per UL 2231
Safety Compliance	UL and cUL, NEC Article 625, RoHS
Protection	Over-Voltage (OVP), Under-Voltage (UVP), Over-Current (OCP), Over-Temperature (OTP), and Short-Circuit Protection
EMC Compliance	FCC Part 15B, Industry Canada (IC), Norma Oficial Mexicana (NOM)
ADA Compliance	Yes
ENERGY STAR Certified	Yes
OPERATIONAL SPECIFICATIONS	
Mounting Type	Wall Mount
Enclosure Rating	NEMA Type 3R Indoor/Outdoor
Operating Temperature	Up to 40 A: -30°C to +50°C (-22°F to +122°F), At 50A: -30°C to +45°C (-22°F to +113°F)
Storage Temperature	-40°C to +80°C (-40°F to +176°F)
Operating Humidity	5 to 95 % Relative Humidity, Non-Condensing
Charger Dimensions	11.65"H x 8.91"W x 4.02"D (296mm H x 226.2mm W x 102.2mm D)
Package Dimensions	18.15"H x 14.80"W x 11.42"D (461mm H x 376mm W x 290mm D)
Charger Weight (Unpackaged)	20.94lbs. (9.5kg)
Charger Weight (Packaged)	23.15lbs. (10.5kg)

Blink reserves the right to alter product offerings and specs at any time without notice and is not responsible for typographical or graphical errors that may appear in this document.

Table 2. Product Specifications

---

## 5. PRE-INSTALLATION INSTRUCTIONS

### 5.1. Safety and Grounding

#### 5.1.1. Safety Check



CAUTION: DISCONNECT ELECTRICAL POWER PRIOR TO INSTALLING THE BLINK CHARGING STATION. FAILURE TO DO SO MAY CAUSE PHYSICAL INJURY OR DAMAGE TO THE ELECTRICAL SYSTEM AND BLINK PRODUCT.

The Blink Product should be installed only by a licensed contractor, and/or a licensed electrician in accordance with all applicable state, local and national electrical codes and standards.

Before installing the Blink Product, review this manual carefully and consult with a licensed contractor, licensed electrician and trained installation expert to ensure compliance with local building practices, climate conditions, safety standards, and state and local codes.

Use appropriate protection when connecting to the main power distribution cable. Use tools as outlined in the "Tools Required for Installation" section.

#### 5.1.2. Grounding Instructions

This product must be connected to a grounded, metal, permanent wiring system; and an equipment grounding conductor must be run with the circuit conductors and connected to the equipment grounding terminal or lead on the product.



## 5.2. Conduit & Breaker Size Guide

All Specifications are Per Charging Station or Port					
Max. Output (Charging) Current	Typical Circuit Breaker (CB) <sup>3</sup>	Typical Wire Specs <sup>3</sup>	Typical Conduit Size <sup>3</sup>	Blink IQ 200 Enclosure Input Conduit Size	Notes / Assumptions
12A	15A	Two #12AWG Wires (Line) One #12AWG Wire (Ground)	1/2"	1"	≤150ft. One-Way Distance ≤3% Voltage Drop
16A	20A	Two #10AWG Wires (Line) One #12AWG Wire (Ground)	3/4"	1"	≤150ft. One-Way Distance ≤3% Voltage Drop
24A	30A	Two #8AWG Wires (Line) One #10AWG Wire (Ground)	3/4"	1"	≤150ft. One-Way Distance ≤3% Voltage Drop
32A	40A	Two #8AWG Wires (Line) One #10AWG Wire (Ground)	3/4"	1"	≤150ft. One-Way Distance ≤3% Voltage Drop
40A	50A	Two #6AWG Wires (Line) One #8AWG Wire (Ground)	3/4"	1"	≤150ft. One-Way Distance ≤3% Voltage Drop
48A	60A	Two #4AWG Wires (Line) One #8AWG Wire (Ground)	1"	1"	≤150ft. One-Way Distance ≤3% Voltage Drop
50A	70A	Two #4AWG Wires (Line) One #8AWG Wire (Ground)	1"	1"	≤150ft. One-Way Distance ≤3% Voltage Drop

<sup>3</sup>Consult with a licensed contractor, licensed electrician, or trained installation expert to ensure compliance with local building codes and safety standards.

Table 3. Conduit and Breaker Size Guide

## 6. INSTALLATION INSTRUCTIONS

### 6.1. Tools Required for Installation

Tools
Security Torx T20 Driver
Wire Cutters
Wire Strippers
Torque Wrench
Drill
Drill Bits
Slotted Screwdriver
P3 Phillips Screwdriver
Heat Shrink Tube

Table 4. Tools Required for Installation

### 6.2. Parts Required for Installation

Part	Quantity	Notes
HQ 200 Smart Charger 50A	1	Included
Mounting Bracket	1	Included
Mounting Screws, Wood, 5/16"	2	Commercially Available
Mounting Anchors, Masonry, 5/16"	4	Commercially Available
Conduit Fitting, 1"	1	Commercially Available
Conduit, 1"	As Needed	Commercially Available

Table 5. Parts Required for Installation

### 6.3. Terminal, Wire Size, and Temperature

Terminal	Wire Size	Temperature
L1/L2	6 AWG	90 °C
Ground	10 AWG	90 °C

Table 6. Terminal Information

## 6.4. Product Installation

- STEP 1:** Remove front cover screws.
- STEP 2:** Remove the front cover.
- STEP 3:** Remove the Installation cover screws.
- STEP 4:** Remove installation cover.

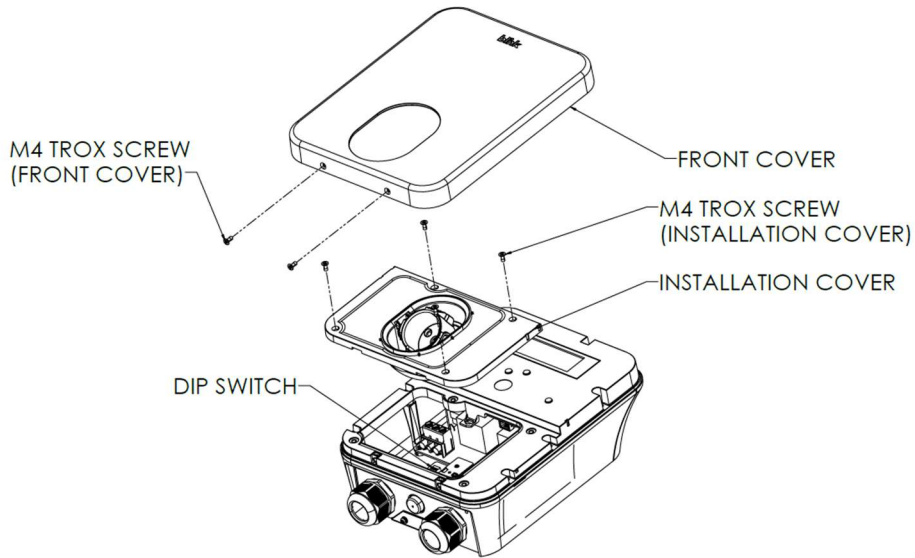

Figure 1. Exploded View of HQ 200 Charger

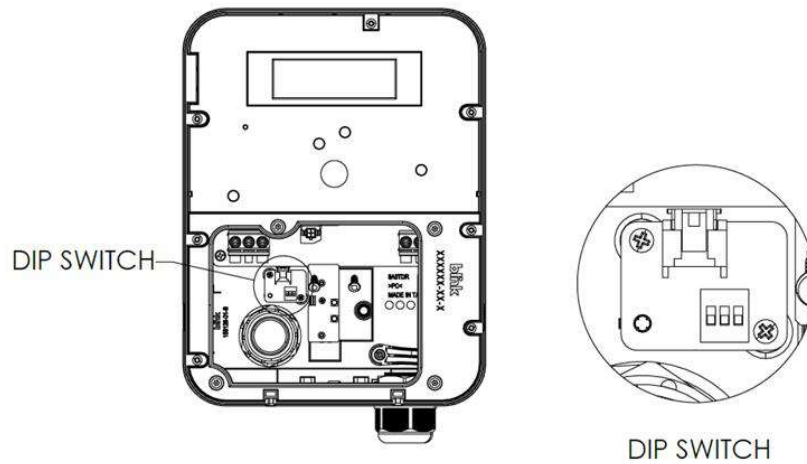

Figure 2. DIP Switch

**STEP 5:** Set maximum current by configuring the DIP switch using the following Figure:

Current/Function	Circuit Breaker Specification	DIP Switch			Figure
		SW1	SW2	SW3	
Reset Factory Default (*)	N/A	OFF	OFF	OFF	
12A	15A	OFF	OFF	ON	
16A	20A	OFF	ON	OFF	
24A	30A	OFF	ON	ON	
32A	40A	ON	OFF	OFF	
40A (Default)	50A	ON	OFF	ON	
50A	70A	ON	ON	OFF	
48(*)	60A	ON	ON	ON	

Figure 3. DIP Switch Configuration

**WARNING:** Power must remain off before setting or configuring the DIP switch.

**STEP 6:** Secure the main body mounting bracket to the wall with appropriate screws.

Follow applicable accessibility requirements for the mounting position. The unit shall be stored or located at a sufficient height above the floor. For an indoor site, it should be not lower than 18" (450 mm) and not higher than 4" (1.2m). For an outdoor site, it should be not lower than 24" (600 mm) and not higher than 4" (1.2m). Refer to Article 625, NEC.

The mounting bracket has six screw holes for wall mounting. If only two screws are used for mounting, the screws should pass through the middle two screw holes of the mounting bracket. The other screw holes are reserved for the user.

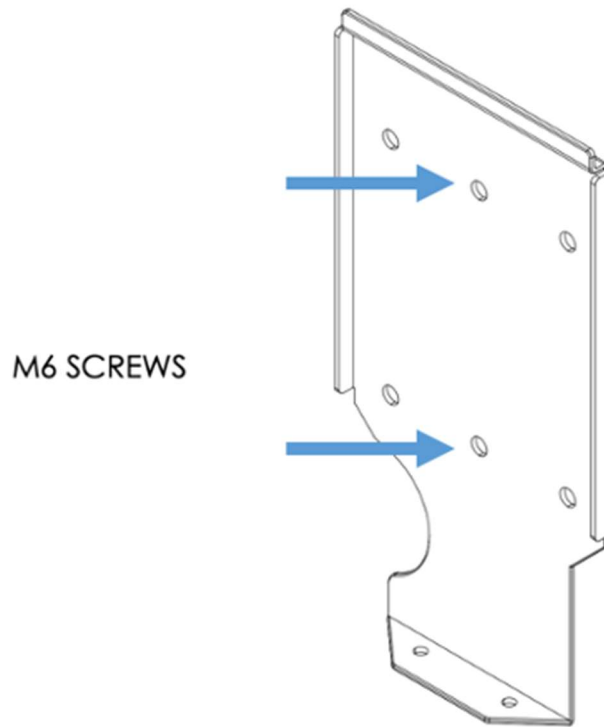

Figure 4. Fasten Mounting Bracket

- A. For masonry walls, use M6 mechanical screws (commercially available).
- B. For finished walls supported by wood studs, use #12 self-tapping screws.
- C. Please refer to the following torque. The actual torque is according to the wall material.

Screw	Torque	
M6	25 kgf.cm min	21.7 lb.-in min
#12	25 kgf.cm min	21.7 lb.-in min

Table 7. Mounting Bracket Torque Values

**STEP 7:** Hang the product on the mounting bracket.

**STEP 8:** Slide down the product to rest on the bottom flange.

**STEP 9:** Install the locking screws (M4 Torx).

**STEP 10:** Reassemble the Install Cover and Front Cover with M4 screws using 15 kgf.-cm (12 lb.-in.).

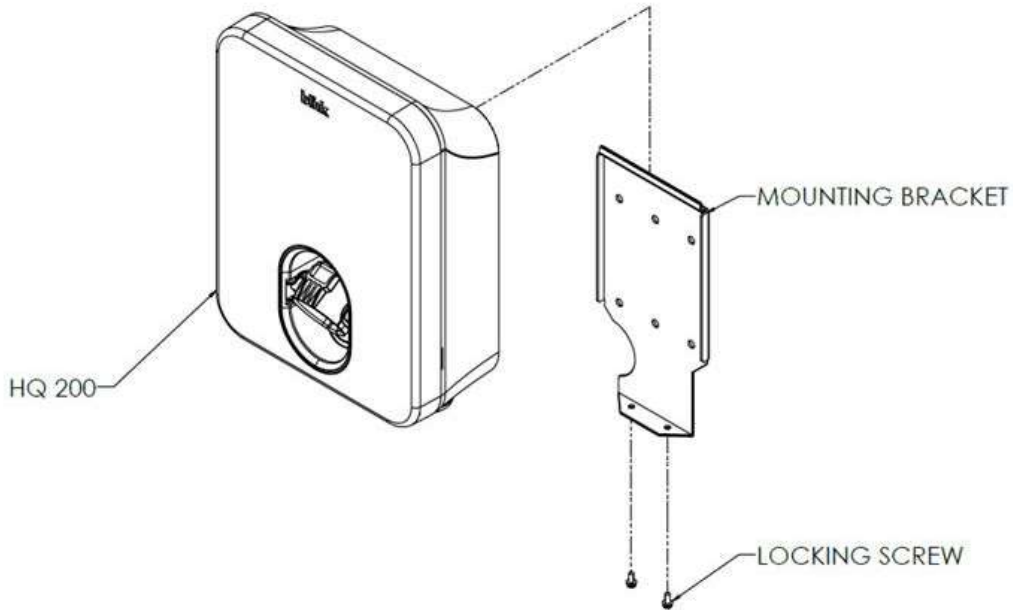

Figure 5. HQ 200 Charger and Mounting Bracket

## 7. Getting Started

### 7.1. Browser Access

#### 7.1.1. Local Network Setup

The charger's factory default network setting is a Wi-Fi Access Point (AP). You can access the charger by Wi-Fi using a phone or computer. The Wi-Fi network name (SSID) is a number on the label on the side of the EVSE. Please refer to Figure . The SSID name is IC80A+SN. The default password is "SN+@IC80A".

Ex. SN : Ex-1193-1A13-1-1234-2444,

The SSID name is IC80AEx-1193-1A13-1-1234-2444.

The password is Ex-1193-1A13-1-1234-2444@IC80A.

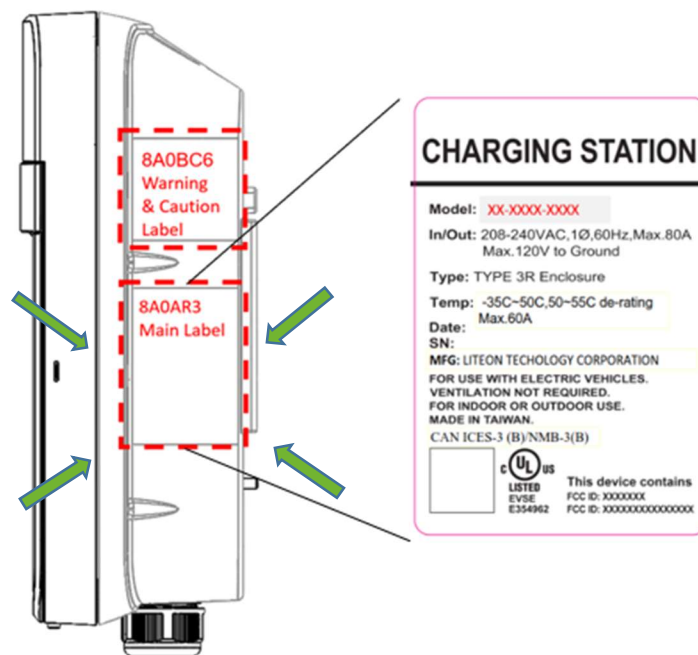

Figure 6. Serial Number Location on Main Label

### 7.1.2. Login

Open a web browser (Internet Explorer for example) and enter the IP address (10.10.0.1) in the address field of the browser and press enter.

The login screen appears as shown in the figure below.



The image shows a login form for the Blink web portal. At the top is the 'blink' logo. Below it are two input fields: 'User Name:' and 'Password:'. A 'Login' button is positioned below the password field.

Figure 7. Web Portal Screen

Enter "**admin**" in the user name box. The default password is "**howru2RU2IC3**".



## 7.2. Web page overview

### 7.2.1. Menu overview

To navigate via the web browser, use the menu items available: Configuration, Maintenance, EVSE Status, LLM Status, and Security, as shown in the figure below.



Figure 8. Menu Overview

### 7.2.2. Configuration Menu

When you choose the **Configuration** menu, a sub menu will appear as shown in the figure below.

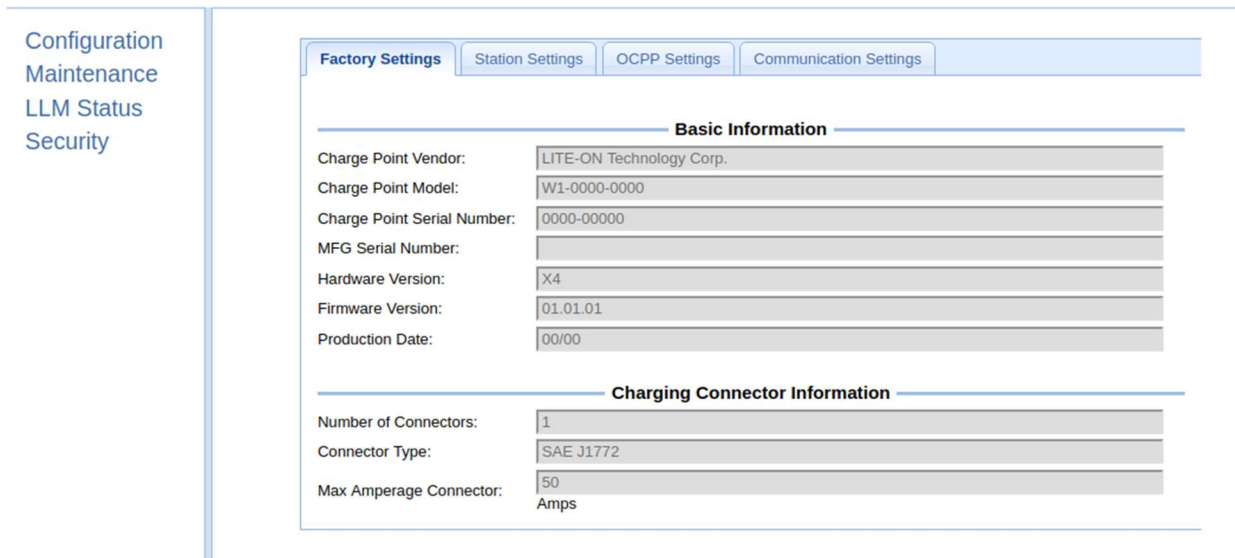

Figure 9. Menu Overview – Configuration

- The **“Factory Settings”** tab is used to display the information of the EVSE.
- The **“Station Settings”** tab is used to set up the configuration regarding to the EVSE itself.
- The **“OCPP Settings”** tab is used to set up the custom properties for uses in OCPP 1.6 services.

- The “**Communication Settings**” tab is used to set up the network connection and load management.

### 7.2.3. Maintenance Menu

When you choose the **Maintenance** menu, a sub menu will appear as shown in the figure below.

The screenshot displays a web interface for the Maintenance menu. On the left is a vertical navigation menu with the following items: Configuration, Maintenance (highlighted in blue), LLM Status, and Security. The main content area is divided into three sections, each with a blue header:

- Command**: Contains two buttons: "Reboot" and "Reset to MFG default".
- Change Serial Number**: Contains a text input field labeled "Serial Number:" and a "Change Serial Number" button.
- Firmware Upgrade**: Contains a "Choose File:" label, a "Browse..." button, the text "No file selected.", and an "Upload" button with a blue arrow icon.

Figure 10. Menu Overview – Maintenance

- The “**Command**” screen can be used to restart the EVSE and reset settings to Manufacturing default.
- The “**Change Serial Number**” screen can change the serial number of the EVSE.
- The “**Firmware Upgrade**” screen can be used to upgrade the firmware of the EVSE.

### 7.2.4. LLM Status Menu

When you choose the **LLM Status** menu, a sub menu will appear as shown in the figure below.

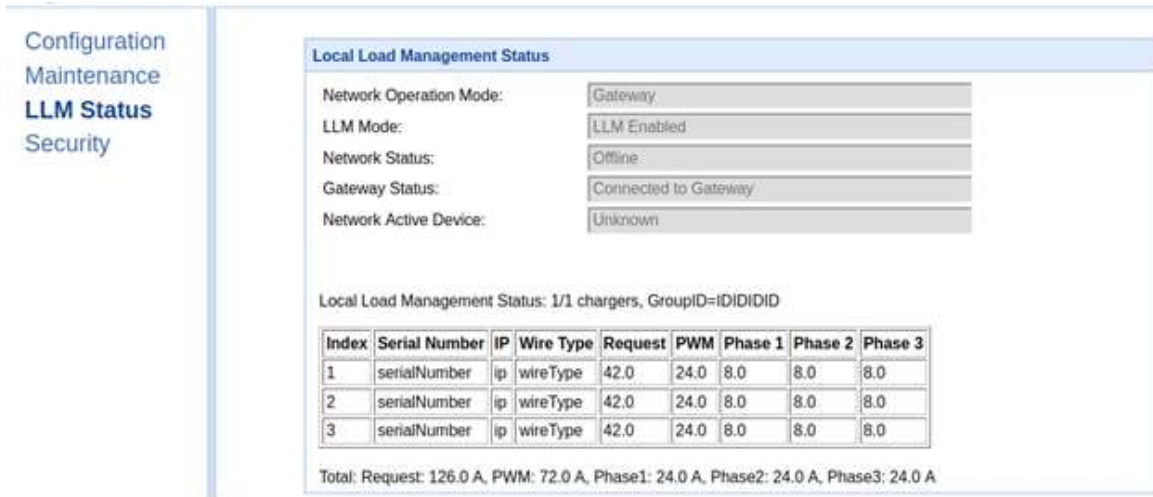

Figure 11. Menu Overview - LLM Status

The “**Local Load Management Status**” screen shows the Local Load Management (LLM) settings and current Parent/Child group member list.

### 7.2.5. Security Menu

When you choose the **Security** menu, a sub menu will appear as shown in the figure below.



Figure 12. Menu Overview - Security

The “**Change Password**” screen can be used to change the password of users for this web portal.

## 7.3. Configuration

### 7.3.1. Factory Settings

Clicking on the “**Configuration**” and then “**Factory Settings**” link will bring up the following screen:

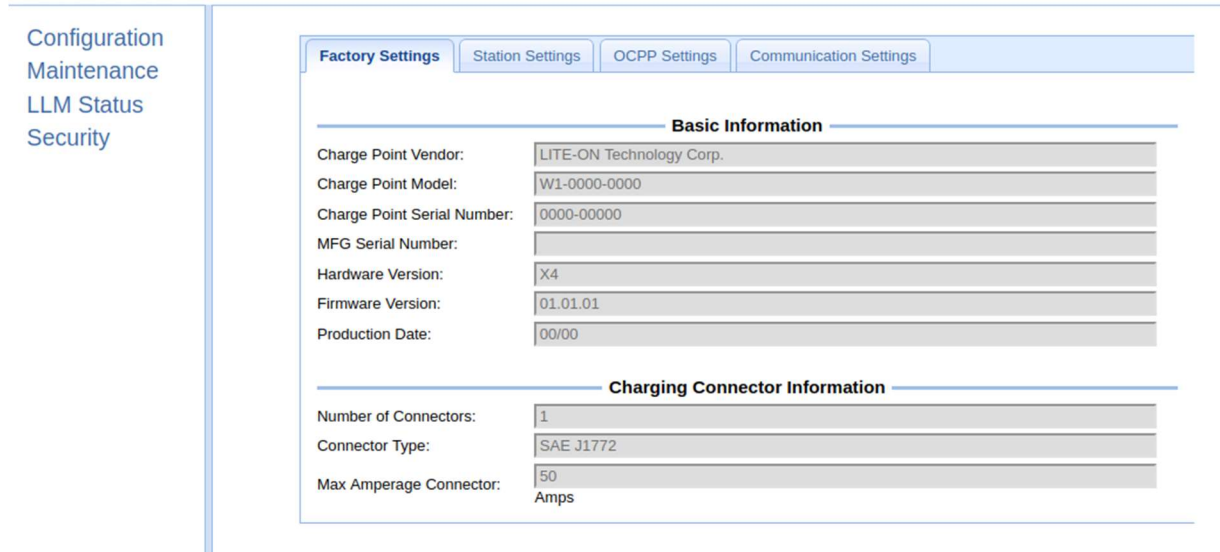

Basic Information	
Charge Point Vendor:	LITE-ON Technology Corp.
Charge Point Model:	W1-0000-0000
Charge Point Serial Number:	0000-00000
MFG Serial Number:	
Hardware Version:	X4
Firmware Version:	01.01.01
Production Date:	00/00

Charging Connector Information	
Number of Connectors:	1
Connector Type:	SAE J1772
Max Amperage Connector:	50 Amps

Figure 13. Menu Overview – Configuration

#### Basic Information

- **EVSE Vendor** – The vendor’s name of the EVSE.
- **EVSE Model** – The model’s name of the EVSE.
- **EVSE Serial Number** – The unique serial number of the EVSE.
- **Firmware Version** – The software version of the EVSE.
- **Production Date** – The production date of the EVSE.

#### Charging Connector Information

- **Number of Connectors** – Number of connectors of the EVSE.
- **Connector Type** – Indicates type 1 or type 2 cable installed in the EVSE.
- **Max Amperage Connector** – The maximum charging current of the connector capability.

### 7.3.2. Station Settings

Clicking on the **“Configuration”** and then **“Station Settings”** link will bring up the following screen shown below in

Figure . On this page you can change the properties of the EVSE. Click the **“Apply”** button at the right side of the property when the value is changed.

Configuration

Maintenance

LLM Status

Security

Factory Settings
Station Settings
OCPP Settings
Communication Settings

**Default Hours of Operation Settings**

NOTE: Settings sent from the Central System will supersede these Default Settings.

	Start Time [HHMM]	End Time [HHMM]
Monday:	<input type="text" value="1000"/>	<input type="text" value="2359"/>
Tuesday:	<input type="text" value="0000"/>	<input type="text" value="2359"/>
Wednesday:	<input type="text" value="0000"/>	<input type="text" value="2359"/>
Thursday:	<input type="text" value="1000"/>	<input type="text" value="2359"/>
Friday:	<input type="text" value="0000"/>	<input type="text" value="2359"/>
Saturday:	<input type="text" value="0000"/>	<input type="text" value="2359"/>
Sunday:	<input type="text" value="0000"/>	<input type="text" value="2359"/>

**Warning Settings**

Temperature Low:	<input type="text" value="85"/>	deg C
Temperature High:	<input type="text" value="170"/>	deg C
Voltage Low:	<input type="text" value="-35"/>	VAC
Voltage High:	<input type="text" value="270"/>	VAC

**General Settings**

Output Power Type:	<input type="text" value="AC"/>	
Power Phase Connected:	<input type="text" value="1"/>	
Max Amperage HW Setting:	<input type="text" value="50"/>	Amps
Max Amperage FW Setting:	<input type="text" value="50"/>	Amps
PWM Amperage:	<input type="text" value="0.00"/>	Amps
Real Amperage:	<input type="text" value="0.00"/>	Amps
Cold Load Pickup Max Delay:	<input type="text" value="720"/>	Seconds
EV Connect Timeout:	<input type="text"/>	Seconds

Plug and Charge ID:	<input type="text"/>	
Offline Authorize:	<input type="text" value="On"/>	
Authorize Timeout:	<input type="text" value="60"/>	Seconds
Reboot Period:	<input type="text" value="10080"/>	Minutes
Local Language*:	<input type="text" value="English"/>	
Reservation Supported:	<input type="text" value="Yes"/>	
Resume Charge After Reboot:	<input type="text" value="Off"/>	
Dim Option:	<input type="text" value="1 min."/>	
Dim Intensity:	<input type="text" value="10%"/>	
Odometer Screen:	<input type="text" value="Off"/>	
Daylight Saving Time Enabled:	<input type="text" value="Yes"/>	
Time Zone:	<input type="text" value="(UTC-08:00) Baja California"/>	
Default Latitude:	<input type="text" value="0.000000"/>	
Default Longitude:	<input type="text" value="0.000000"/>	

Figure 14. Configuration - Station Settings

## Default Hours of Operation Settings

## Warning Settings

## General Settings

- **Output Power Type** – AC or DC output power. For SC/IC series, this value is always “AC”.
- **Power Phase Connected** – Input power phase connected to the EVSE to indicate single phase or three phases. For SC/IC series, this value is always “1”.
- **Max Amperage HW Setting** – The DIP switches (Hardware) settings to indicate the maximum charging current.
- **Max Amperage FW Setting** – The software settings to indicate the maximum charging current.
- **PWM Amperage** – The PWM setting for charging current when the EVSE is online. This signal is to tell EV how much current is allowed to use.
- **Real Amperage** – The real-time charging current detected by the EVSE.
- **Cold Load Pickup Max Delay** – Default cold load pickup delay is 120s ~ 720s. The max value could be changeable by this property.
- **Plug and Charge ID** – If the value is present, the EVSE needs to support plug and charge scenario by using the specific identifier. If absent, authorization for each session is required. This ID must be 8 or more characters.
- **Reservation Supported** – If true, the EVSE will support reservation related messages from Central System.
- **Resume Charge After Reboot** – Indicate if the EVSE resumes charging after power recycle. If true, the EVSE will resume charging according to UL regulations. If false, the EVSE will not resume charging.

Default price and station location information are shown below in the figures below.

- Configuration
- Maintenance
- LLM Status
- Security

### Default Pricing Settings

NOTE: Settings sent from the Central System will supersede these Default Settings.

Member Price Scheme ID:	<input type="text" value="2"/>
NonMember Price Scheme ID:	<input type="text" value="0"/>
Parking Billing Type:	<input type="text" value="Time"/>
Parking Day of Week:	<input type="text" value="Everyday"/>
Parking Start Time:	<input type="text" value="1000"/> [HHMM]
Parking End Time:	<input type="text" value="2359"/> [HHMM]
Parking Unit Interval:	<input type="text" value="30"/> Sess./Time
Parking Interval Rate:	<input type="text" value="1"/> USD
Parking Grace Period:	<input type="text" value="1"/> Seconds
Usage Billing Type:	<input type="text" value="Session"/>
Usage Day of Week:	<input type="text" value="Wednesday"/>
Usage Start Time:	<input type="text" value="0000"/> [HHMM]
Usage End Time:	<input type="text" value="2359"/> [HHMM]
Usage Unit Interval:	<input type="text" value="30"/> Sess./Time/KWh
Usage Interval Rate:	<input type="text" value="1"/> USD
Usage Grace Period:	<input type="text" value="1"/> Seconds
Initial Grace Period:	<input type="text" value="0"/> Seconds
Parking Rate Cap:	<input type="text" value="0.00"/> USD
Tax Rate:	<input type="text" value="0.00"/> %
Service Fee:	<input type="text"/> USD

Figure 15. Station Setting - Default Price Settings

### GPS Information

Latitude:	<input type="text"/>
Longitude:	<input type="text"/>

Figure 16. Station Setting - GPS Information



### 7.3.3. OCPP Settings

Clicking on the “**Configuration**” and then “**OCPP Settings**” link will display the menu as shown in the figure below.

Factory Settings
Station Settings
OCPP Settings
Communication Settings

Configuration

Maintenance

LLM Status

Security

**Remote Service Settings**

Remote Service Type\*: BlinkOCPP1.5J

*Important: This Apply button only changes the Remote Service Type. For all other changes, use the Apply button at the bottom of this page.*

✔ Apply

**Service Settings**

Charge Point ID: L1-0207-1922-001684

Protocol Name: BlinkOCPP1.5

Central System URL\*: wss://ocpp.blinknetwork.com/BlinkOCPP1\_5

Basic Auth ID\*: ocpp

Basic Auth Password\*: \*\*\*\*

FTP Server Username: ocpp

FTP Server Password: \*\*\*\*

Message Transport Layer: WS

WebSocket Ping Interval:   
Seconds

Boot Notification Interval: 600  
Seconds

Boot Notification Retries: -1

Heartbeat Interval:   
Seconds

PDU Timeout: 60  
Seconds

Reset Retries:

Download Firmware Interval: 300  
Seconds

Download Firmware Retries: 3

Upload Diagnostic Interval: 300  
Seconds

Upload Diagnostic Retries: 3

Download AD Interval: 300  
Seconds

Download AD Retries: 3

Meter Sampling Type: Periodic

Meter Value Sample Interval:   
Seconds

Clock Aligned Data Interval:   
Seconds

Figure 17. Configuration - OCPP Settings

On this page you can change the properties just for the EVSE. Click the “**Apply**” button at the right side of the property when the value is changed.

BlinkCharging.com

Page 25 of 52

---

## Remote Service Settings

**Remote Service Type:** The remote-control mode accepted by charger. Options are:

**APP:** Charger is controlled by mobile APP.

**OCPP:** Charger is controlled by OCPP 1.6 protocol.

## Service Settings

- **EVSE ID** – The identity of the EVSE as known in the OCPP Central System.
- **Protocol Name** – The name and version of OCPP is running in the EVSE.
- **Central System URL** – The URL of the OCPP v1.6 Central System service.
- **Basic Auth ID** – The ID for BASIC authentication in HTTPS (SSL/TLS) connections.
- **Basic Auth Password** – The password for BASIC authentication in HTTPS (SSL/TLS) connections.
- **FTP Server Username** – The username of the FTP Server for OCPP to download firmware files and upload diagnostic file.
- **FTP Server Password** – The password of the FTP Server for OCPP to download firmware files and upload diagnostic file.
- **Message Transport Layer** – Select the transport layer of the OCPP service that will be used. The available option is **WS and WSS**.
- **WS:** Connection from EVSE to OCPP Server uses WebSocket protocol.
- **WSS:** Connection from EVSE to OCPP Server uses Secure WebSocket protocol.
- **Boot Notification Interval** – Interval of re-sending BootNotification.req if not accepted by Central System.
- **Boot Notification Retries** – Number of times to retry sending BootNotification.req.
  - "-1" means unlimited
  - "0" means don't retry.
- **PDU Timeout** – Interval until the EVSE stop waiting for a Power Delivery Unit (PDU) response.
- **Download Firmware Interval** – Interval of downloading firmware from Central System.
- **Download Firmware Retries** – Number of times to retry downloading firmware.
- **Upload Diagnostics Interval** – Interval of uploading diagnostic file to Central System.
- **Upload Diagnostics Retries** – Number of times to retry uploading diagnostic file.

OCPP1.6 Settings	
AllowOfflineTxForUnknownId:	Yes ▾
AuthorizationCacheEnabled:	Yes ▾
AuthorizeRemoteTxRequests:	Yes ▾
BlinkRepeat:	0 Times
ClockAlignedDataInterval:	0 Seconds
ConnectionTimeOut:	900 Seconds
GetConfigurationMaxKeys:	60
HeartBeatInterval:	0 Seconds
LightIntensity:	100 %
LocalAuthorizeOffline:	Yes ▾
LocalPreAuthorize:	Yes ▾
MaxEnergyOnInvalidId:	7360 Wh
MeterValuesAlignedData:	Energy.Active.Import.Register ▾
MeterValuesAlignedDataMaxLength:	10
MeterValuesSampledData:	Energy.Active.Import.Register ▾
MeterValuesSampledDataMaxLength:	10
MeterValueSampleInterval:	0 Seconds
MinimumStatusDuration:	10 Seconds

Figure 18. Configuration - OCPP 1.6 Settings

## OCPP1.6 Settings

These settings are defined and requested for support in OCPP 1.6 specification.

- **AllowOfflineTxForUnknownId** – If set to yes, an unknown ID (not in Authorization and Cache List) will be accepted and start the charging session when EVSE is not connected to central system.
- **AuthorizationCacheEnabled** – If set to yes, the Authorization Cache is enabled.
- **AuthorizeRemoteTxRequests** – Whether a remote request to start a transaction in the form of a **RemoteStartTransaction.req** message should be authorized beforehand like a local action to start a transaction.
- **BlinkRepeat** – Number of times to blink the EVSE lighting when signaling. This value is not changeable for IC/SC.
- **ClockAlignedDataInterval** – Size (in seconds) of the clock-aligned data interval. This is the size (in seconds) of the set of evenly spaced aggregation intervals per day, starting at 00:00:00 (midnight).
- **ConnectionTimeOut** – Interval (from successful authorization) until incipient Transaction is automatically canceled, due to failure of EV driver to (correctly) insert the charging cable connector(s) into the appropriate socket(s).
- **GetConfigurationMaxKeys** – Maximum number of requested configuration keys in a GetConfiguration.req PDU.
- **HeartBeatInterval** – Defines the heartbeat interval.
- **LightIntensity** – Percentage of maximum intensity at which to illuminate the EVSE lighting. This value is not changeable for IC/SC.

- **LocalAuthorizeOffline** – Whether the EVSE, when offline, will start a transaction for locally-authorized identifiers.
- **LocalPreAuthorize** – Whether the EVSE, when online, will start a transaction for locally authorized identifiers without waiting for or requesting an Authorize.conf from Central System.
- **MaxEnergyOnInvalidId** – Maximum energy in Watt-hour (Wh) delivered when an identifier is invalidated by Central System after start of a transaction.
- **MeterValuesAlignedData** – Clock-aligned measurand(s) to be included in a MeterValues.req PDU, every **ClockAlignedDataInterval** seconds. Supported value are Current.Import, Energy.Active.Import.Register, and Temperature, Voltage or any combination of these 4 values.
- **MeterValuesAlignedDataMaxLength** – Maximum number of items in a MeterValuesAlignedData configuration key.
- **MeterValuesSampledData** – Sampled measurands to be included in a MeterValues.req PDU, every **MeterValueSampleInterval** seconds. Supported value are Current.Import, Energy.Active.Import.Register, and Temperature, Voltage or any combination of these 4 values.
- **MeterValuesSampledDataMaxLength** – Maximum number of items in a MeterValuesSampledData configuration key.
- **MeterValueSampleInterval** – Interval between sampling of metering (or other) data, intended to be transmitted by "MeterValues" PDUs
- **MinimumStatusDuration** – The minimum duration that a EVSE or connector status is stable before a StatusNotification.req PDU is sent to Central System.

maintenance

LLM Status

Security

NumberOfConnectors:		1
ResetRetries:		0
ConnectorPhaseRotation:		NotApplicable ▾
ConnectorPhaseRotationMaxLength:		1
StopTransactionOnEVSideDisconnect:		Yes ▾
StopTransactionOnInvalidId:		Yes ▾
StopTxnAlignedData:		Current.Import,Energy.Active.Import.Register,Temperature,Voltage ▾
StopTxnAlignedDataMaxLength:		10
StopTxnSampledData:		Current.Import,Energy.Active.Import.Register,Temperature,Voltage ▾
StopTxnSampledDataMaxLength:		10
SupportedFeatureProfiles:		Core,Firmware,Management,Local Auth List Management,Reservation,SmartCharging ▾
SupportedFeatureProfilesMaxLength:		6
TransactionMessageAttempts:		10
TransactionMessageRetryInterval:		10
UnlockConnectorOnEVSideDisconnect:		Yes ▾
WebSocketPingInterval:		120
LocalAuthListEnabled:		Yes ▾
LocalAuthListMaxLength:		100
SendLocalListMaxLength:		100
ReserveConnectorZeroSupported:		Yes ▾
ChargeProfileMaxStackLevel:		99
ChargingScheduleAllowedChargingRateUnit:		Current
ChargingScheduleMaxPeriods:		32
ConnectorSwitch3to1PhaseSupported:		No ▾
MaxChargingProfilesInstalled:		10

✔ Apply

Figure 19. Configuration - OCPP 1.6 Settings (continued)

- **NumberOfConnectors** – The number of physical charging connectors of this EVSE.
- **ResetRetries** – Number of times to retry an unsuccessful reset of the EVSE.
- **ConnectorPhaseRotation** – The phase rotation per connector in respect to the connector's energy meter. Possible values per connector are:
  - NotApplicable (for single phase)
  - Unknown (not (yet) known)
  - RST (Standard Reference Phasing)
  - RTS (Reversed Reference Phasing)
  - SRT (Reversed 240 degree rotation)
  - STR (Standard 120 degree rotation)
  - TRS (Standard 240 degree rotation)
  - TSR (Reversed 120 degree rotation)
- **ConnectorPhaseRotationMaxLength** – Maximum number of items in a ConnectorPhaseRotation configuration key.
- **StopTransactionOnEVSideDisconnect** – When set to true, the EVSE SHALL administratively stop the transaction when the cable is unplugged from the EV.
- **StopTransactionOnInvalidId** – Whether the EVSE will stop an ongoing transaction when it receives a non-accepted authorization status in a StartTransaction.conf for this transaction.
- **StopTxnAlignedData** – Clock-aligned periodic measurand(s) to be included in the TransactionData element of StopTransaction.req MeterValues.req PDU for every ClockAlignedDataInterval of the charging session. Supported value are Current.Import, Energy.Active.Import.Register, and Temperature, Voltage or any combination of these 4 values.
- **StopTxnAlignedDataMaxLength** – Maximum number of items in a StopTxnAlignedData configuration key.
- **StopTxnSampledData** – Sampled measurands to be included in the TransactionData element of StopTransaction.req PDU, every MeterValueSampleInterval seconds from the start of the charging session. Supported value are Current.Import, Energy.Active.Import.Register, and Temperature, Voltage or any combination of these 4 values.
- **StopTxnSampledDataMaxLength** – Maximum number of items in a StopTxnSampledData configuration key.
- **SupportedFeatureProfiles** – A list of supported Feature Profiles. Possible profile identifiers: Core, FirmwareManagement, LocalAuthListManagement, Reservation, SmartCharging and RemoteTrigger.
- **SupportedFeatureProfilesMaxLength** – Maximum number of items in a SupportedFeatureProfiles configuration key.
- **TransactionMessageAttempts** – How often the EVSE should try to submit a transaction-related message when Central System fails to process it.
- **TransactionMessageRetryInterval** – How long the EVSE should wait before resubmitting a transaction-related message that Central System failed to process.

- **UnlockConnectorOnEVSideDisconnect** – When set to true, the EVSE SHALL unlock the cable on EVSE side when the cable is unplugged at the EV. This is not supported by IC/SC since it is plug type and no connector locker.
- **WebSocket Ping Interval** – Define the ping pong interval for WebSocket protocol.
- **LocalAuthListEnabled** – Whether the Local Authorization List is enabled.
- **LocalAuthListMaxLength** – Maximum number of identifications that can be stored in the Local Authorization List.
- **SendLocalListMaxLength** – Maximum number of identifications that can be send in a single SendLocalList.req.
- **ReserveConnectorZeroSupported** – If this configuration key is present and set to true: The EVSE support reservations on connector 0.
- **ChargeProfileMaxStackLevel** – Max Stack Level of a Charging Profile. The number defined also indicates the max allowed number of installed charging schedules per Charging Profile purposes.
- **ChargingScheduleAllowedChargingRateUnit** – A list of supported quantities for use in a Charging Schedule. This value will always be 'Current' for IC/SC.
- **ChargingScheduleMaxPeriods** – Maximum number of periods that may be defined per Charging Schedule.
- **ConnectorSwitch3to1PhaseSupported** – If defined and true, this EVSE supports switching from 3 to 1 phase during a charging session. This field is read only.
- **MaxChargingProfilesInstalled** – Maximum number of charging profiles installed at a time.

#### 7.3.4. Communication Settings

Clicking on the “**Configuration**” and then “**Communication Settings**” link will bring up the following screen. Since the page is too long to display, we separate it to couple screens. On this page you can set up the network connection. To finish, click the “**Apply**” button.

Configuration

Maintenance

LLM Status

Security

Factory Settings
Station Settings
OCPP Settings
Communication Settings

Network Mode\*:

UI Mode\*:

Gateway LAN IP:

Max Group Size:

Unit Number\*:

Gateway Serial Number:

Gateway DNS\*:

Hide AP SSID:

Connectivity:

Ping URL:

---

**Active Device Status**

Active Device:

Active IP Address:

Active Netmask:

Active Gateway:

Active Primary DNS:

Active Secondary DNS:

Figure 20. Communication Settings

Network Mode – Specifies if enable the Local Proxy function.

- **Direct:** Use EVSE as a standalone device.
- **Gateway:** Use EVSE as a gateway EVSE. Gateway connected to OCPP 1.6 Server via cellular, Ethernet or Wi-Fi and connected to other EVSEs (called Client) via Wi-Fi or Ethernet and forms a local EVSEs group. This group is also a LAN (Local Area Network).
- **Client:** Use EVSE as a client EVSE. Client connected to Gateway via Wi-Fi/Ethernet. Client connected to OCPP1.6 Server through gateway EVSE (via cellular/Ethernet/Wi-Fi) and Gateway will dispatch incoming remote command to proper client EVSEs (or Gateway itself).

### NOTE

A Gateway EVSE can choose using Wi-Fi/Cellular/Ethernet to connect to the internet by changing the 'Group Use External Gateway' setting. If set to Yes, a **Gateway** will use Cellular/Wi-Fi/Ethernet. When changed this setting, the 'Connectivity' option will automatically change as well.

All EVSE in this Gateway/Client group must have the same 'Group Use External Gateway' setting. All EVSEs must set this option to Yes (including **Gateway** and **Client**) when we want to use an external Wi-Fi AP to connect to internet. In this case, all EVSEs must also use the same Wi-Fi settings (SSID, password) for the external Wi-Fi AP.

If you want to change web portal setting of Direct, Gateway and Client mode, please refer to the separate address of web portal.

Direct / Gateway EVSE: 10.10.0.1

Client EVSE: 10.10.0.2

**Connectivity** – Specifies whether the EVSE should always be connected to Internet using None, Auto, Wi-Fi, or Cellular. Default value is Auto.

**Gateway Serial Number** – The serial number of the EVSE which acts as a Gateway.

Gateway LAN IP – The IP of master in LAN. This value cannot be modified by users.

**Max Group Size** – The maximum number of EVSEs allowed in a group/LAN is 20. This value cannot be modified by users.

**Hide AP SSID** – Options for hiding SSID of this EVSE or not. For IC/SC this option is always off.

**Active Device Status**

- **Active Device** – Current active network device. Possible values are None, Ethernet, Wi-Fi or Cellular
- **Active IP Address** – Current active IP address. There will be value here only if connected to a network.
- **Active Netmask** – Current active netmask address. There will be value here only if connected to a network.
- **Active Gateway** – Current active gateway IP address. There will be value here only if connected to a network and network provide this data.
- **Active Primary DNS** – Current active primary DNS IP address. There will be value here only if connected to a network and network provide this data.
- **Active Secondary DNS** – Current active secondary DNS IP address. There will be value here only if connected to a network and network provide this data.

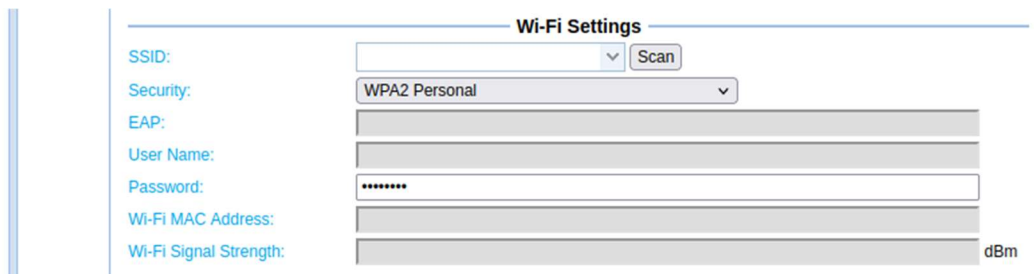

Figure 21. Wi-Fi Settings

**Wi-Fi Settings**

- **SSID** – The SSID name of Wi-Fi Access Point. Press Scan button to scan and receive current detectable Wi-Fi signal.
- **Security** – The encryption of Wi-Fi Access Point. Options are None, WEP, WPA-PSK, WPA2-PSK, WPA-PSK+WPA2-PSK and Auto.
- **Password** – The password of Wi-Fi Access Point.
- **Wi-Fi MAC Address** – Display Wi-Fi device hardware MAC address.



- 
- **Wi-Fi Signal Strength** – Display the wireless signal strength of Wi-Fi in dBm.

## 7.4. Maintenance

The maintenance page is shown in the below figure.



Figure 22. Maintenance Screen

### 7.4.1. Reboot

**Reboot:** To restart the EVSE.

**Reset Factory Default:** This command will restore all settings (e.g. password, network settings, maximum amperage) to the manufacturer default values.

**DIP Switch Reset:** Power off the unit and configure DIP switch into the off position as shown in the table below.

Current/Function	Circuit Breaker Specification	DIP Switch			Figure
		SW1	SW2	SW3	
Reset Factory Default (*)	N/A	OFF	OFF	OFF	

Table 8. Reset Factory Default – DIP Switch Configuration

### Charging Profile Data

**HINT:** Local authorization is defined in OCPP 1.6 specification. There are two local lists: Local Authorization List and Authorization Cache List. The Local Authorization List is a list of identifiers that can be synchronized with the Central System. An Authorization Cache autonomously maintains a record of previously presented identifiers that have been successfully authorized by the Central System.

#### 7.4.2. Firmware Upgrade

To upgrade the firmware of the EVSE, you need to download the upgrade image file to your local hard disk, and then click the “**Choose File**” button to locate the firmware file on your computer. Once you have selected the new firmware file, click the “**Upload**” button to start the upgrade process. After a successful upgrade, the EVSE will reboot.

Although the web portal does not forbid upload firmware to previous version, downgrading firmware may cause unpredicted problem and is not recommended.

### 7.5. LLM Status

#### 7.5.1. LLM information

This page shows the Local Load Management information of the EVSE. For more LLM description, please refer to section 7.5.3.

**Network Operation Mode:** Indicates the EVSE is in Direct mode, a Gateway or a Client.

**LLM Mode:** Indicates Local Load Management function is enabled or disabled.

**Network Status:** Indicates if the EVSE is online or not.

**Gateway Status:** Indicates if the EVSE is connected to the Gateway if it's a Client. For Direct and Gateway, it always shows “Connected to Gateway”.

**Network Active Device:** Indicates the Network connected via which device. It could be Offline, Wi-Fi or Cellular.

**Local Load Management Status:** Display connected EVSEs, total EVSEs, Group ID of the LLM group as well as a full table of detail information each EVSE if this EVSE is Gateway.

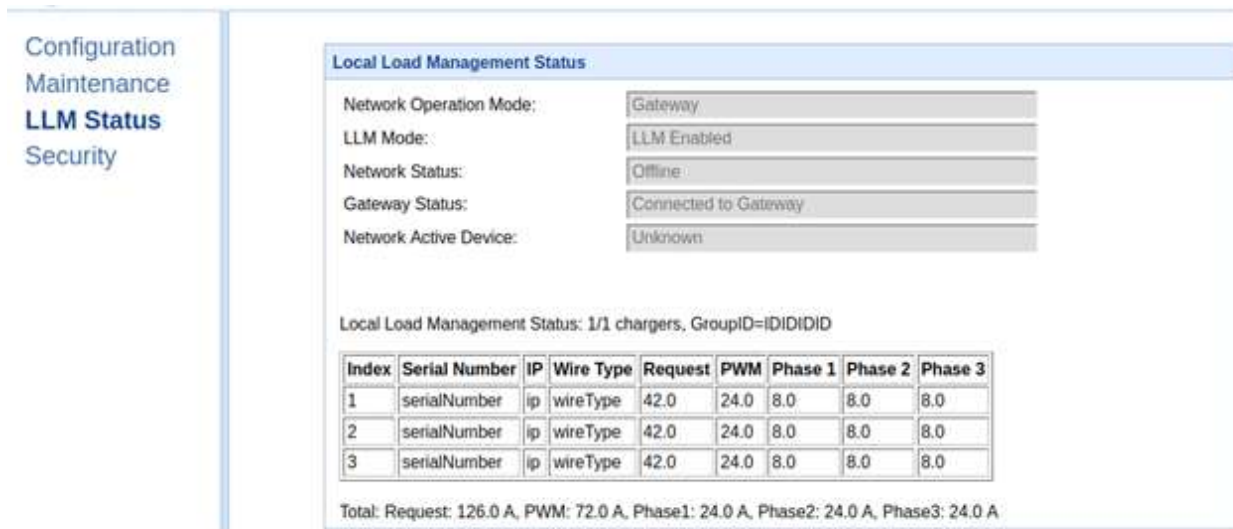

Figure 24. LLM Status

### 7.5.2. Gateway/Client Group Table

If the EVSE is Gateway, the following LLM Group Table is present.

Index: The order of the EVSE. The index is first connected to Gateway first showed.

Serial Number: The serial number (EVSE Identity) of each EVSE.

IP: The private local IP address in LLM group of each EVSE.

Wire Type: The power source wire type of each EVSE.

Request: The requested current of each EVSE

PWM: The PWM (charger allowed) current of each EVSE

Phase 1, Phase 2, Phase 3: The real current loaded by the vehicles of each EVSE.

### 7.5.3. Operation Mode

There are two different operation modes each time when a new coming car starts charging, **Distribution mode** and **Priority mode**. The LLM gateway will re-calculate the proper ampere for each charging station based on the different mode.

**Distribution Mode** (Uniform Distribution)

The available current is divided equally amongst all available charging stations.

**Example 1**

In this example, there are three (32A) charging stations in the LLM group. Setting up each charging stations according to the following settings:

Setting	Gateway	Client
<b>Local Load Management</b>	Enable	Enable
<b>Charging Policy</b>	Uniform Distribution	Not used
<b>Group ID</b>	LLM-Group-1	LLM-Group-1 (Same as Gateway)
<b>Group Size</b>	3	Not used
<b>Max Amperage Grid Connection</b>	60	Not used
<b>Fallback Current</b>	10	10 (Same as Gateway)

Table 9. Example 1 – LLM Settings

With one connected vehicle, the charging current is 32A.

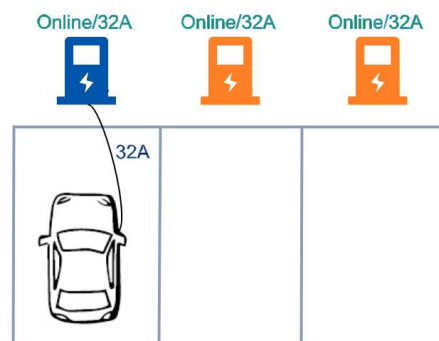

Figure 25. Example 1 – One Connected Vehicle

With two connected vehicles, the charging currents are evenly reduced to 30A.

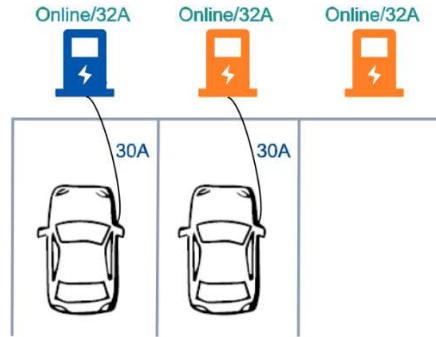

Figure 26. Example 1 – Two Connected Vehicles

With three connected vehicles, the charging currents are further reduced to 20A.

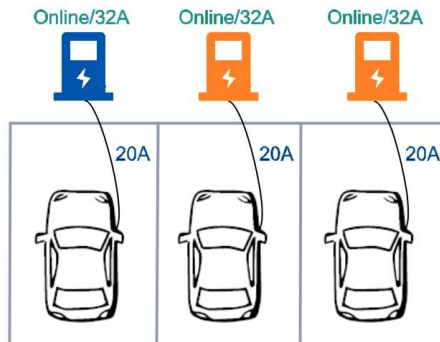

Figure 27. Example 1 – Three Connected Vehicles

**Example 2**

In this example, there are two (32A) charging stations and one (16A) charging station in the LLM group. Setting up each charging stations according to the following settings:

Setting	Gateway	Client
<b>Local Load Management</b>	Enable	Enable
<b>Charging Policy</b>	Uniform Distribution	Not used
<b>Group ID</b>	LLM-Group-1	LLM-Group-1 (Same as Gateway)
<b>Group Size</b>	3	Not used
<b>Max Amperage Grid Connection</b>	60	Not used
<b>Fallback Current</b>	10	10 (Same as Gateway)

Table 10. Example 2 – LLM Settings

With one connected vehicle, the charging current is 32A.

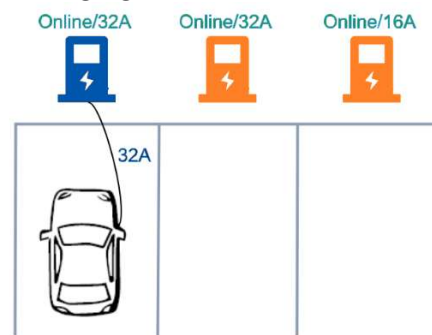

Figure 28. Example 2 – One Connected Vehicle

With two connected vehicles, the charging currents are evenly reduced to 30A.

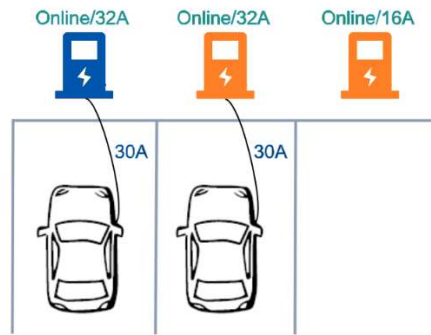

Figure 29. Example 2 – Two Connected Vehicles

With three connected vehicles, the charging currents are further reduced to 24A for 32A charging stations and the charging current is 12A for 16A charging station.

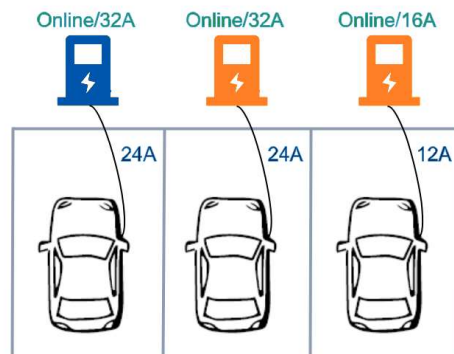

Figure 30. Example 2 – Three Connected Vehicles

### Example 3

In this example, there are five (32A) charging stations in the LLM group and two of the charging stations are offline. Setting up each charging station according to the following settings:

Setting	Gateway	Client
Local Load Management	Enable	Enable
Charging Policy	Uniform Distribution	Not used
Group ID	LLM-Group-1	LLM-Group-1 (Same as Gateway)
Group Size	5	Not used
Max Amperage Grid Connection	80	Not used
Fallback Current	10	10 (Same as Gateway)



Table 11. Example 3 – LLM Settings

With one connected vehicle, the charging current is 32A. (Reserve 20A for offline charging stations)

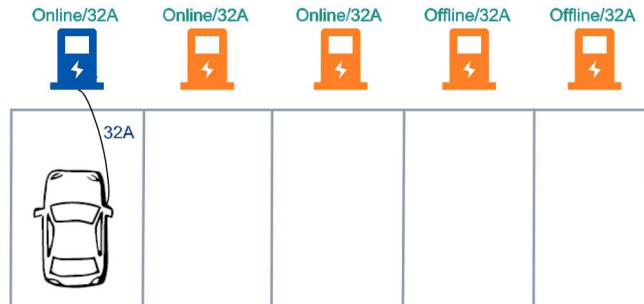

Figure 31. Example 3 - One Connected Vehicle

With two connected vehicles, the charging currents are evenly reduced to 30A. (Reserve 20A for offline charging stations)

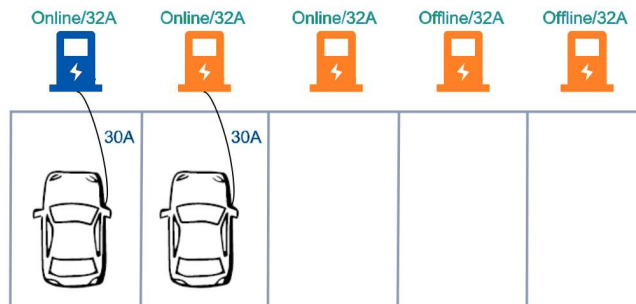

Figure 32. Example 3 – Two Connected Vehicles

With three connected vehicles, the charging currents are further reduced to 20A. (Reserve 20A for offline charging stations)

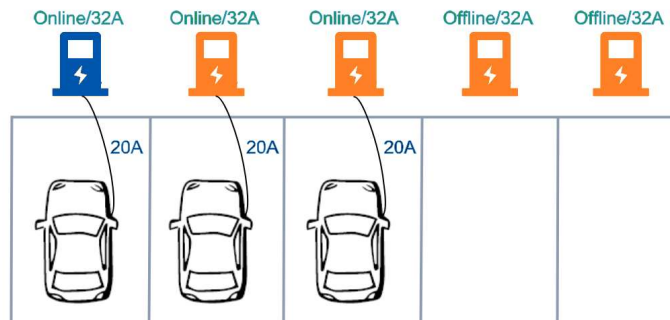

Figure 33. Example 3 – Three Connected Vehicles

**Priority Mode** (First Come First Serve)

The available current is NOT divided equally amongst all available charging stations. The first vehicle connected would be allocated as much as possible. If any current capacity is left, then the remainder would be given to the other charging stations.

**Example A**

In this example, there are three (32A) charging stations in the LLM group. Setting up each charging stations according to the following settings:

Setting	Gateway	Client
<b>Local Load Management</b>	Enable	Enable
<b>Charging Policy</b>	First In First Serve	Not used
<b>Group ID</b>	LLM-Group-1	LLM-Group-1 (Same as Gateway)
<b>Group Size</b>	3	Not used
<b>Max Amperage Grid Connection</b>	60	Not used
<b>Fallback Current</b>	10	10 (Same as Gateway)

Table 12. Example A – LLM Settings

The first vehicle connected would receive 32A.

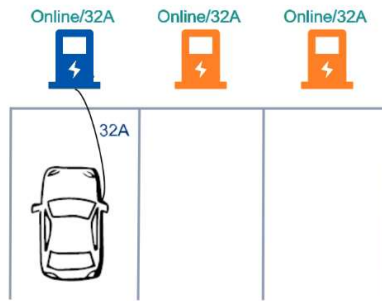

Figure 34. Example A – One Connected Vehicle

The second vehicle would receive 28A.

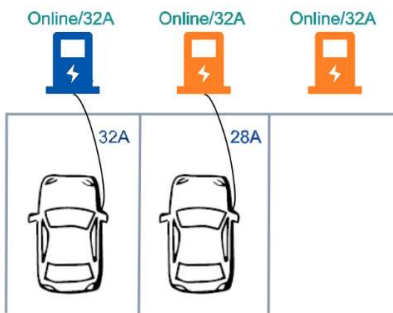

Figure 35. Example A – Two Connected Vehicles

The third vehicle is NOT able to receive current.

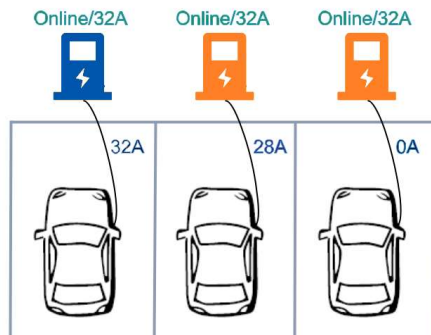

Figure 36. Example A – Three Connected Vehicles

When the first vehicle left, the second vehicle would receive 32A, and the third vehicle would receive 28A.

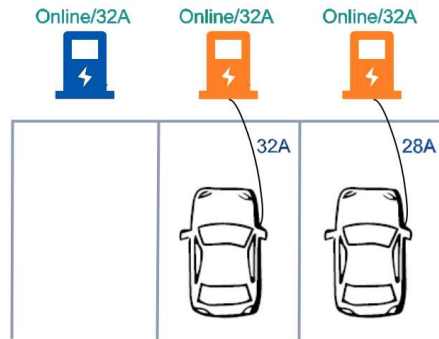

Figure 37. Example A – Two Remaining Vehicles

### Example B

In this example, there are five (32A) charging stations in the LLM group and two of the charging stations are offline. Setting up each charging stations according to the following settings:

Setting	Gateway	Client
<b>Local Load Management</b>	Enable	Enable
<b>Charging Policy</b>	First In First Serve	Not used
<b>Group ID</b>	LLM-Group-1	LLM-Group-1 (Same as Gateway)
<b>Group Size</b>	5	Not used
<b>Max Amperage Grid Connection</b>	100	Not used

<b>Fallback Current</b>	10	10 (Same as Gateway)
-------------------------	----	-------------------------

Table 13. Example B – Priority Model LLM Settings

The first vehicle connected would receive 32A. (Reserve 20A for offline charging stations)

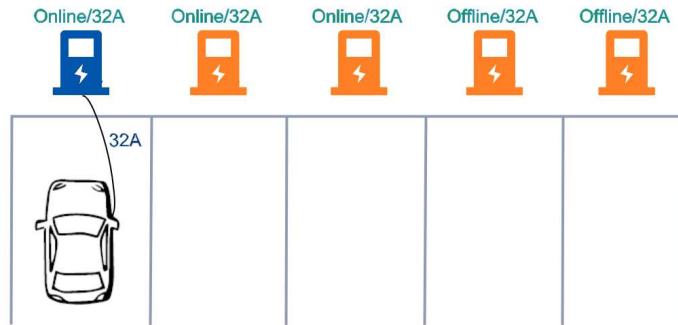

Figure 38. Example B – One Connected Vehicle

The second vehicle would receive 32A. (Reserve 20A for offline charging stations)

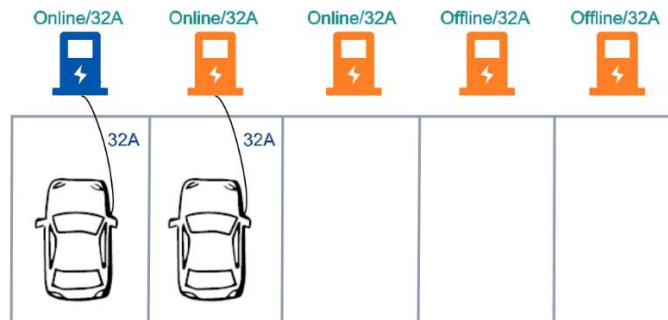

Figure 39. Example B – Two Connected Vehicles

The second vehicle would receive 16A. (Reserve 20A for offline charging stations)

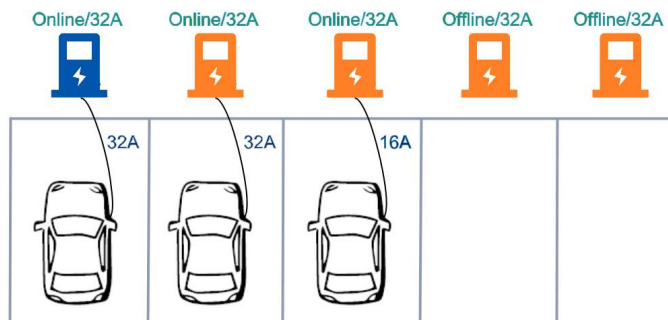

Figure 40. Example B – Three Connected Vehicles

## 7.6. Security

### 7.6.1. Change Password

To change password, first choose user you want to change password. There are two default users – **admin** and **maintain**. Only admin user can access Security Page. Enter old password and new password then select **“Apply”** button to change password of the user. To reset password of all users, press **“Reset password of all users”** button.



Figure 41. Change Password Screen

## 8. Operations

### 8.1. Charging Status Indicators







LED Indicator	Description	Definition
	Not Illuminated	Power Off
	Green Steady	Ready
	Green Flashing	Flashing Green (Fast): Authorized, wait for EV Connect Flashing Green (Slow): Suspend (Occupying)
	Blue Flashing	Flashing Blue (Slow): Charging
	Red Steady	Unrecoverable Fault
	Red Flashing	Recoverable Fault
	Pink Steady	Reserved (from OCPP Service)
	Yellow Steady	Power On / Device Unavailable
	Yellow Flashing	Booting / Firmware Upgrading / Out of Service

Table 14. LED Status Indicators

## 8.2. Authorization

Before the owner of an electric vehicle can start or stop charging, the EVSE has to authorize the operation.

### 8.2.1. Online Authorization

Before the owner of an electric vehicle can start or stop charging, the EVSE has to authorize the operation. The EVSE SHALL only supply energy after authorization.

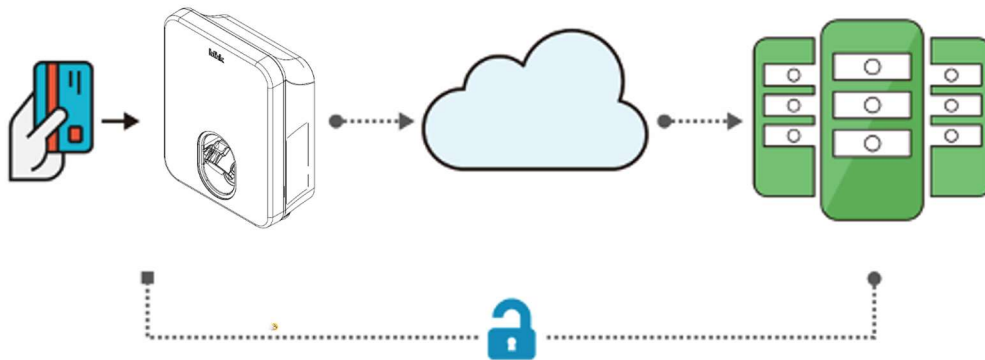

Figure 42. Online Authorization

### 8.2.2. Local Authorization

Synchronized with the Central System when EVSE is Online. To improve the experience for users, the EVSE MAY support local authorization when EVSE is *offline*, and faster authorization response time when communication between EVSE and Central System is slow.

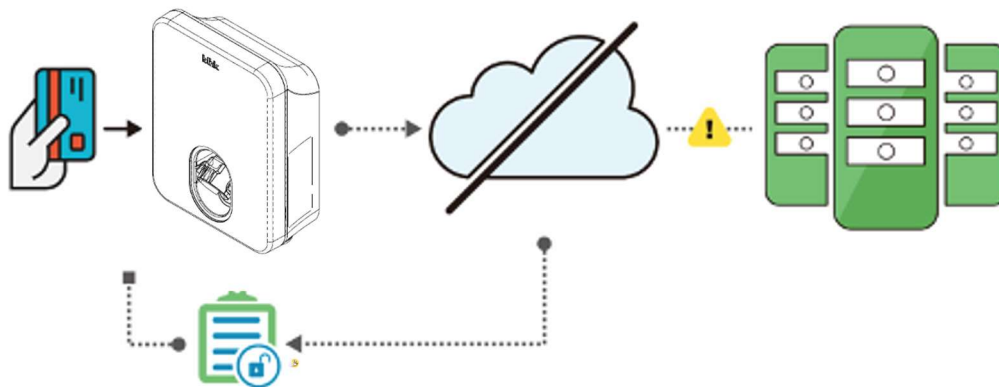

Figure 43. Local Authorization



---

## 8.3. Start Charging

### 8.3.1. Plug and Charge

1. Insert the charging plug into the EV
2. Charging session started

### 8.3.2. RFID Card

1. Insert the charging plug into the EV
2. Swipe card
3. Wait for authorization
4. Charging session starts

## 8.4. Stop Charging

### 8.4.1. Interrupt Charging

5. Unplug any time (disconnect the charging plug from EV to stop charging session)
6. Session ended (please return the connector to the holster)

### 8.4.2. Auto Restart

When a charging session is interrupted due to a temporary error condition, the EVSE will automatically restart charging when the cause of the temporary error condition returns to normal. Status indicator lights remain flashing RED until the error condition is resolved.

- Temporary error conditions include: Over Current, Over Voltage, Under Voltage, and Over Temperature.
- For Over Current conditions: The charging session will be stop while OC occurs. After recovery from OC for 30 seconds, the EVSE will automatically restart charging for three times.
- When charging session stopped due to CCID trip, the EVSE will try to restart after 15 minutes for 3 times.

### 8.4.3. Cold Load Pickup

When power resumes after an outage, the EVSE restarts automatically with a delay ranging from 120 to 720 seconds. The delay is designed to avoid impacting the utility grid when multiple EVSEs are in the same area attempting to resume charging simultaneously.

## 9. General Care

The exterior of the EVSE is designed to be waterproof and dust proof. To ensure proper maintenance of the EVSE, follow these guidelines:

- Despite the water resistance of the enclosure, when cleaning it is preferred to not direct streams of water at the unit. Clean with a soft, damp cloth.
- Make sure the charging plug is put back in the holster after charging to avoid damage.
- Ensure the power cable is stored on the EVSE after use to avoid damage.
- If the power cable or the charging plug is damaged, please contact Customer Support.

## 10. Supplemental Information

### 10.1. Electrical Service Wiring (240V split-phase system (residential))

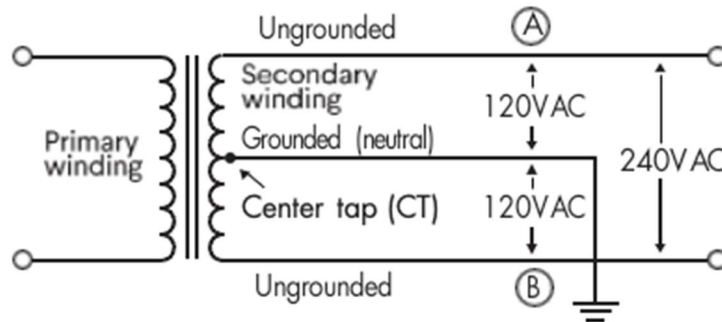

### 10.2. Three-phase 208 V Wye-connected



The center point of the three phases (used as neutral) must be single-point grounded.

In a Wye-connected secondary installation, use two of the legs to provide 208V to the charger. For example, L1 and L2, or L1 and L3, or L2 and L3. The two phases utilized must each measure 120V ground.

Note: a current carrying neutral is not required for charger installation.

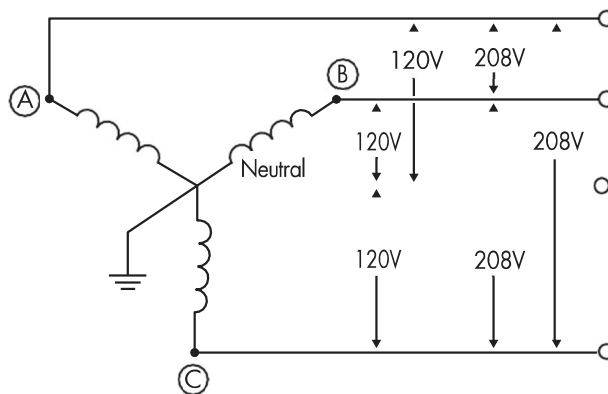

### 10.3. Three-phase 240 V Delta-connected



**DANGER**

- The third leg (A in the illustration) of the delta transformer is 208V to neutral and is sometimes referred to as a “high leg”. Do not use this third leg.
- Do not use a three-phase delta-connected secondary without a ground connection.

In a delta-connected installation, one leg must be center-tapped, and only the two phases on either side of that center tap can be safely utilized. The two used phases must each measure 120V to ground.

Note: the charger’s contactor closes only if it detects the presence of an earth ground wire connected to a neutral point on the transformer secondary.

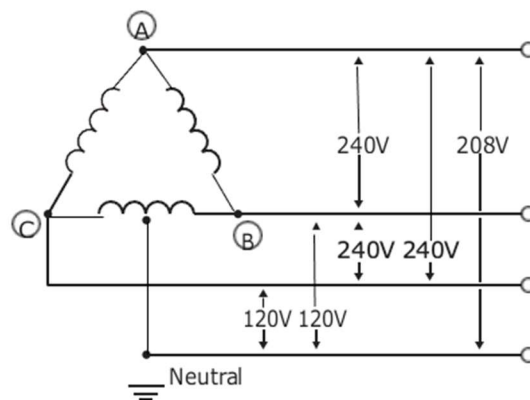

## 11. Customer Support

Please contact your reseller directly for technical support.